

MASONRY PROJECT #41

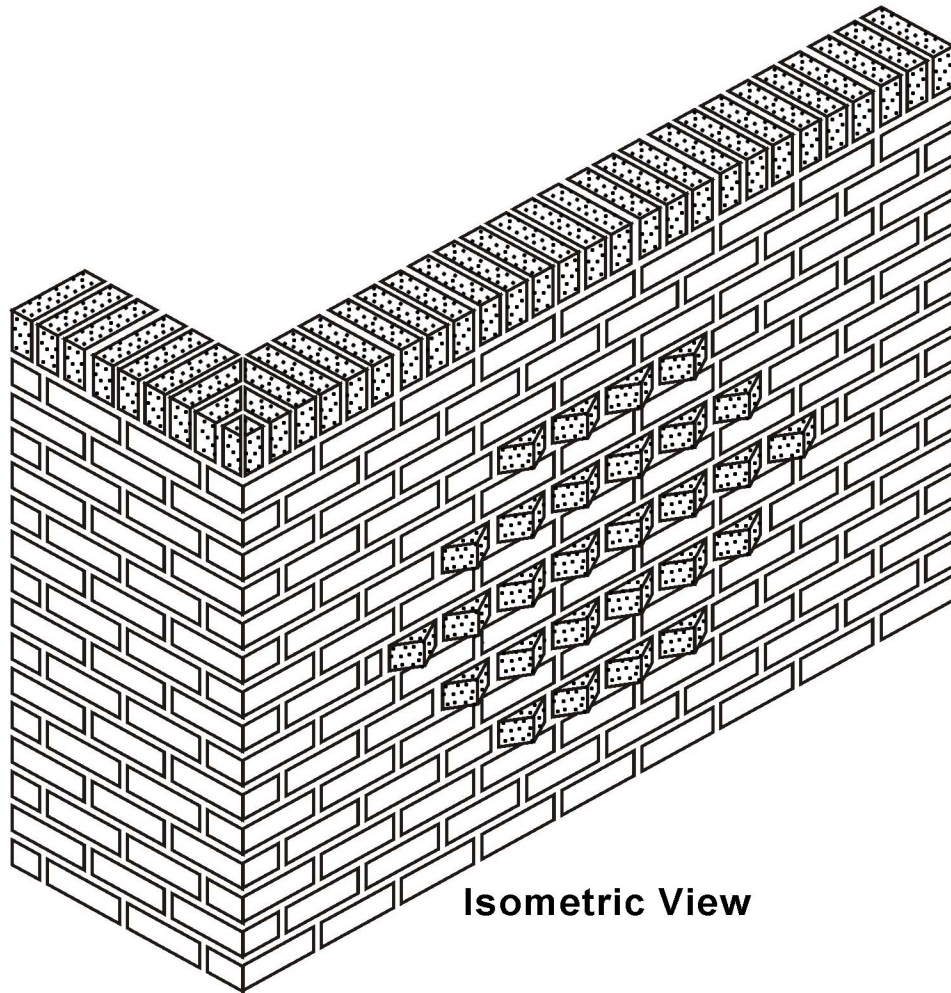

Isometric View

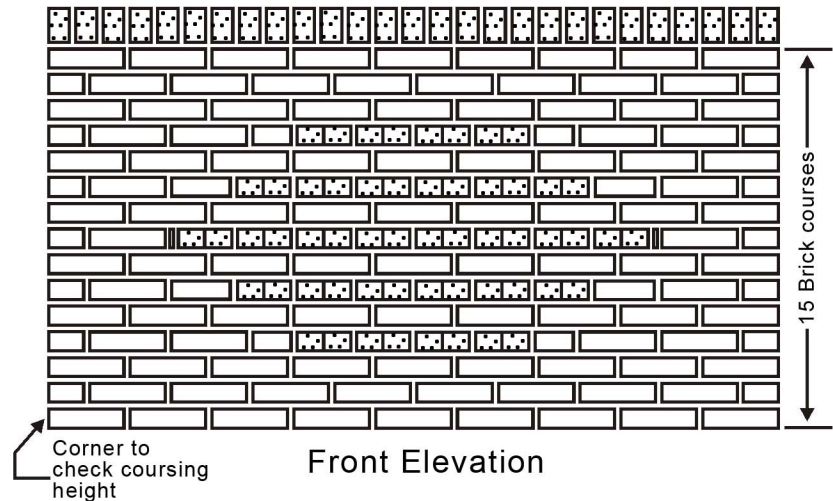

Front Elevation

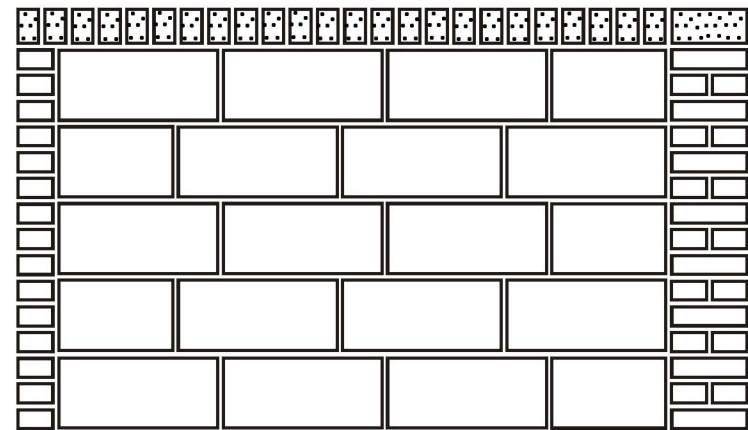

Rear Elevation

**Bon Tool Co. does not guarantee the accuracy of the data.
Please report errors and submit suggestions to Bon Tool Co.**

INSTRUCTIONS

1. Build wall as shown.
2. First course of brick to be used to level project.
3. Brick coursing to be 3 in 8" from top of first course up.
4. Fill all head, and bed joints.
5. Both sides and ends to be finished with concave joint.
6. Clean with brush only.

 - Denotes uncored brick

Bon Tool Co.

Gibsonia, PA 15044 • USA • 724-443-7080 • www.bontool.com

MASONRY PROJECT #41

(Continued)

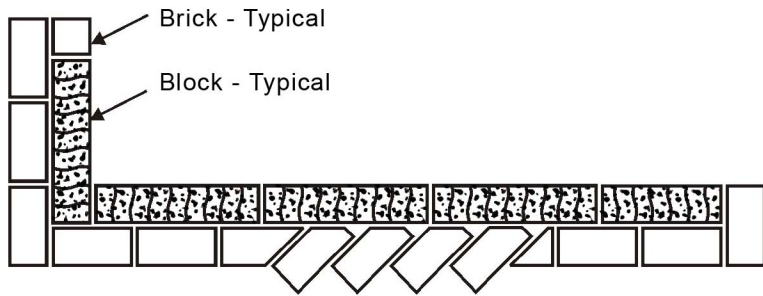

Brick Course # 4 & 12

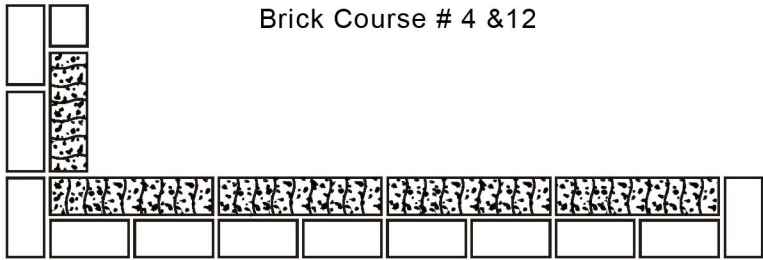

Brick Course # 2 & 14

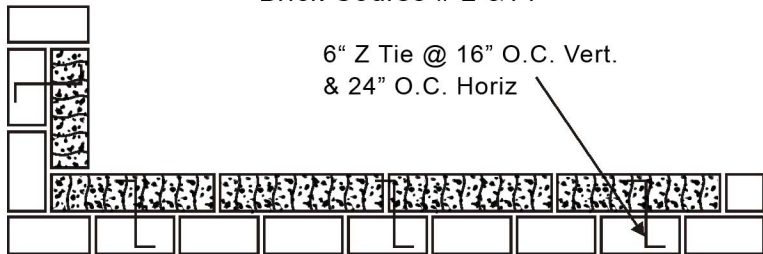

Brick Course # 1, 3, 7, 9, 13 & 15
Tie Courses # 3, 9 & 15

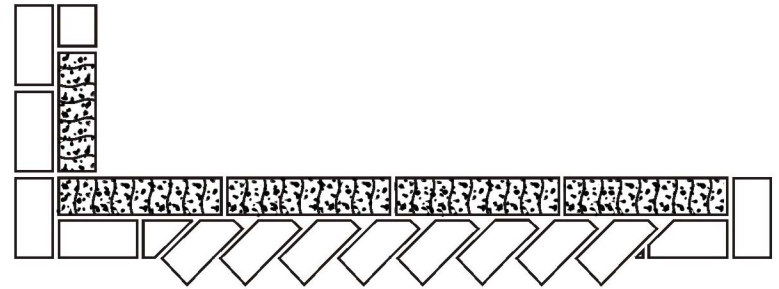
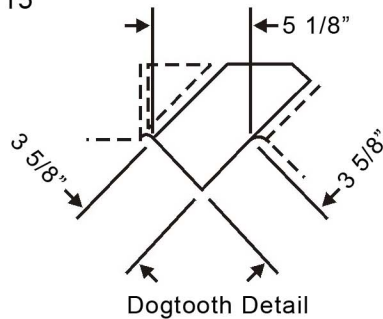

Brick Course # 8

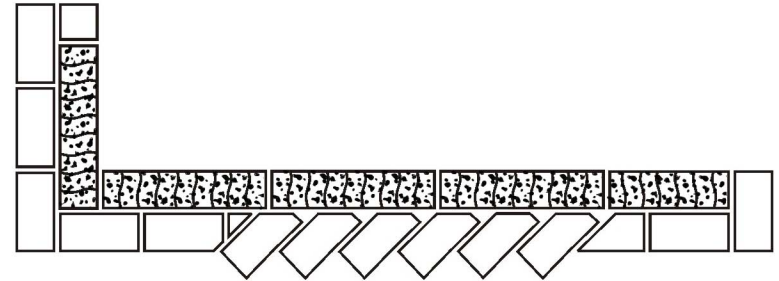

Brick Course # 6 & 10

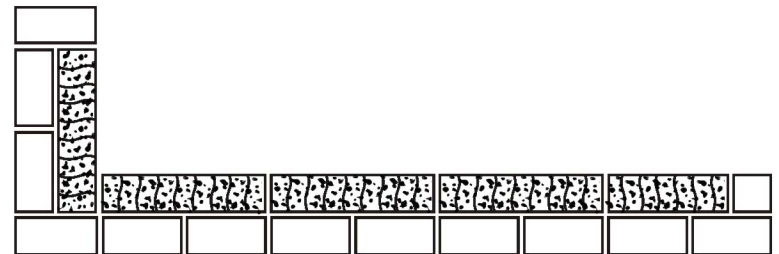

Brick Course # 5 & 11

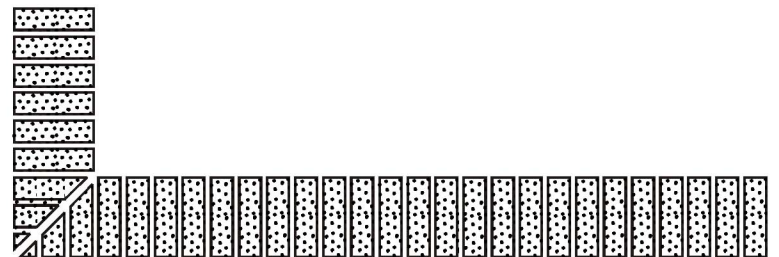

Rowlock Course

Bon Tool Co.

Gibsonia, PA 15044 • USA • 724-443-7080 • www.bontool.com