

INSTRUCTIONS #12-238 3.5 Cu. Ft. Concrete Wheelbarrow Mixer

The Bon Wheelbarrow Mixer has been designed and manufactured to our highest quality demands for performance and durability.

The Bon Wheelbarrow Mixer has a 3.5 cu.ft. total drum and is designed for mixing up to 2 cu. ft of concrete, cement, soil fertilizer or similar materials. Inappropriate use of the machine can cause serious damage and/or bodily harm to the environment or the operator. Always operate this equipment with care and be prepared for specific requirements and work hazards that may exist at the job site.

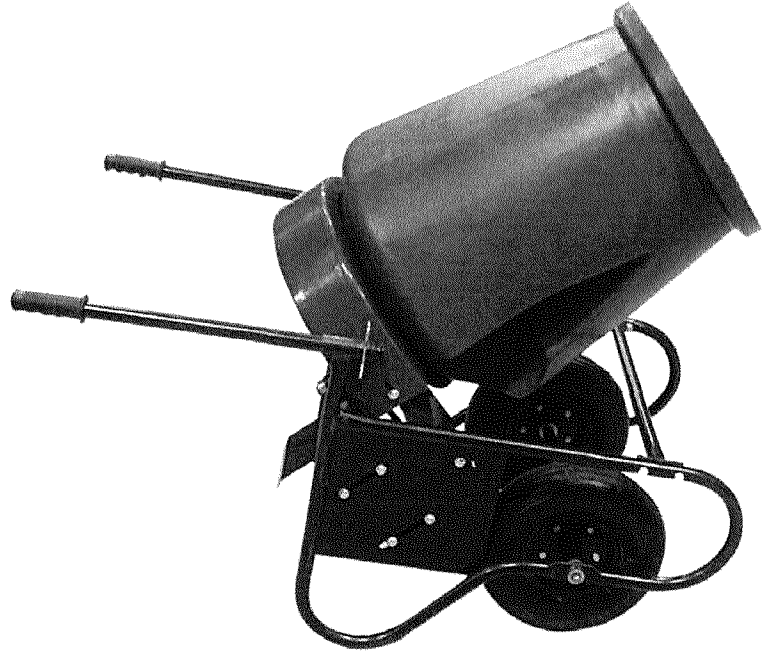

- *Bladeless mixing drum*
- *Unique helix-shaped vortex of the molded drum*
- *Adjustable handles for easy maneuverability and storage*
- *Easy to clean*



CAUTION!

DO NOT operate this equipment until you have read and understood all the enclosed instructions.

READ ALL the sections in this manual PRIOR to attempting to service, maintain or operate this equipment.

CONTENTS OF INSTRUCTION MANUAL

Safety Precautions	page 2
Components	page 4
Assembly	page 5
Parts List	page 12
Operating Procedures	page 13
Maintenance	page 15

Read these instructions thoroughly before using the unit. Important operating procedures, safety precautions, maintenance and troubleshooting tips are contained with these instructions. Please retain these instructions as a reference for later use.

Bon[®]
Trusted since 1958

4430 Gibsonia Rd. • Gibsonia, PA 15044 • USA • www.bontool.com

IS12238 3/20

Safety Precautions

1. READ AND UNDERSTAND OPERATOR'S MANUAL PRIOR TO USE OF CONCRETE MIXER.
2. Before operating concrete mixer, ensure that it is structurally and mechanically safe by checking the following:
 - a. Are any of the protective guards cracked or otherwise damaged?
 - b. Is the drive belt in good condition?
 - c. Are the drive gear and mixing drum gear both in alignment and centered to each other?
 - d. Is the power cord in good condition with no rips, tears, bare wire showing, or fraying?
3. Before using the concrete mixer on proposed jobsite, perform the following environmental checks:
 - a. Inspect the entire work area for unexpected hazards, such as gas and water pipes, electrical wiring or cabling, damp areas or leakages.
 - b. The mixer will not be used in an area of standing water, or that its power cord will be routed through such conditions.
 - c. Electrical power is supplied from a grounded and safe source, and that the source is of the same voltage to that specified on the machine.
4. Before using the concrete mixer on proposed jobsite, make sure that the operator is thoroughly familiar with the machine and its components (see "Machine Overview").
5. When operating the concrete mixer, follow these guidelines for operator's personal safety:
 - a. Always wear proper safety clothing and equipment for the job. These can and should include eye and ear protection, protective helmets, gloves, dust mask and any other items that are appropriate for the job and jobsite requirements
 - b. Never wear any jewelry, neck ties, or other loose or hanging items that can be caught on any part of the machine
 - c. Tie back or remove any loose hair, clothing and any other potential hazards and obstructions
 - d. Keep all hands, loose clothing, hair, jewelry and all other personal parts and belongings away from moving parts of the machine.
 - e. The last operator may have been negligent and his possible oversight could cause you death or serious injury. Inspect machine before each use.
 - f. Always use the proper size grounded outdoor use extension cord, conforming to your local electrical codes and ordinances. **Minimum** acceptable gauge is 4 AWG.
 - g. Never place hands, other body parts of self or others, or large, solid objects into mixing drum.
 - h. NEVER fill machine beyond recommended load of 2 cu.ft of wet and dry ingredients.
 - i. NEVER allow machines to run unattended. **ALWAYS disconnect and store the machine away if operator is not available.**
 - j. The electrical motor will heat up when machine is in use. Machine **must be allowed** to cool before touching it or attempting to perform any maintenance!
6. For the safety of others and that of the operator, observe the following precautions:
 - a. Keep observers and bystanders away from the concrete mixer and its immediate working environment while the machine is in use.
 - b. **Stop** operations or if anyone or anything (i.e.: humans, animals, debris etc.) approaches from any direction while the machine is in operation.
 - c. **Stop** work and turn off the concrete mixer if any debris may have fallen into contact with the gears or drive belt that could jam the machine or cause it to labour unnecessarily. Inspect the concrete mixer and surrounding environment for any possible causes.
 - d. If the machine is jammed, turn the unit off and **disconnect** the concrete mixer from its power source **before** attempting to clear any jams in the unit.
 - e. Stop all work, turn off concrete mixer, and ensure that motor is turned off and cooled before performing any diagnostics or repairs.
 - f. ROTATING CONCRETE MIXER GEARS CAN CAUSE SERIOUS INJURY OR DEATH. DO NOT PLACE HAND ON GEARS FOR ANY REASON UNTIL MACHINE HAS COME TO A FULL STOP

Safety Precautions (continued)

AND HAS BEEN DISCONNECTED FROM ITS POWER SOURCE. DO NOT ATTEMPT TO PERFORM ANY REPAIRS, SERVICE, OR DIAGNOSTICS OR TO TRANSPORT OR MOVE THE UNIT UNTIL MACHINE HAS COME TO A FULL STOP AND HAS BEEN DISCONNECTED FROM ITS POWER SOURCE. FAILURE TO DO SO MAY RESULT IN SERIOUS INJURY OR DEATH.

g. ***Never leave machine unattended***

h. ***DO NOT***, under any circumstances, operate machine if any of the following conditions are applicable:

- i. Any impairment (i.e.: medical conditions, medicinal side-effects, alcohol, drugs etc.) of the operator.
- ii. The operator has not read or understood the operator's manual for this machine.
- iii. The operator does not clearly understand the operations of the machine.
- iv. The machine is in need of repair
- v. The operator is inappropriately attired to operate the machine.

Components

Verify that all of the following components are included with your Bon Concrete Wheelbarrow Mixer #12-238.
DO NOT ATTEMPT ASSEMBLY OR OPERATION WITHOUT ANY OF THESE LISTED PARTS!

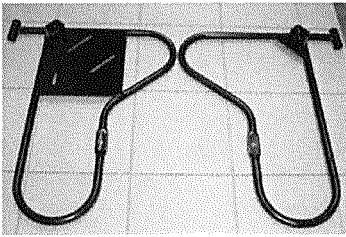

Left & right wheelbarrow frames.

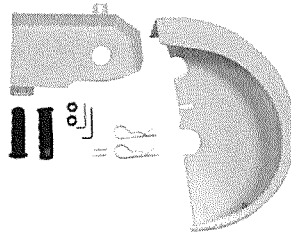

Protective guards, allen keys, handle grips, pins and castle nuts.

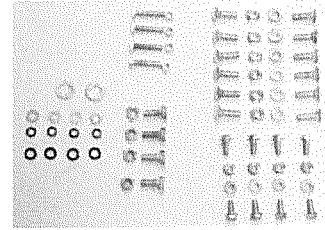

Assorted nuts & bolts for assembly.

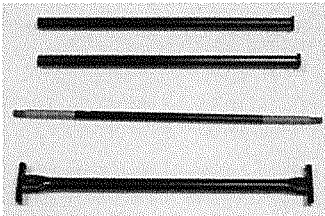

Handle bars, axle and front support bar.

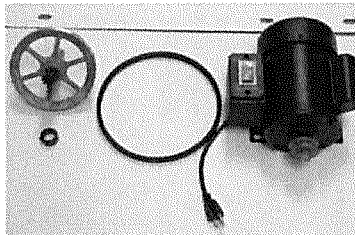

Electric motor, drive belt, jack-shaft and lock ring.

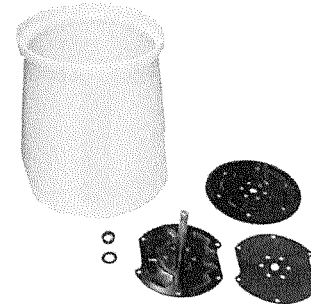

Components for mixing drum assembly.

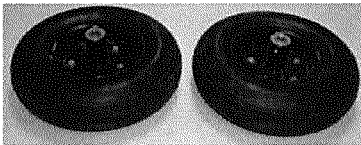

Wheels.

Assembly

Assembling the Frame:

1. Sort through all the components and set aside pieces required for the frame (Fig.1)
2. Slide wheels onto either side of the axle.
3. Place side frames as shown onto axle, taking care that both frames are aligned and perpendicular to the axle (Fig.2)
4. Insert a metal washer onto either end of axle.
5. Screw on one castle nut on either side of axle, taking care to line up slots on the nut with the holes on the axle. Insert one cotter pin through castle nut slots and into the hole on the axle. Repeat on the other side. **DO NOT BEND COTTER PIN AT THIS TIME** (Fig.3)
6. Attach front support bar with bolts provided (Fig.4)
7. Bolt on drum support beam. Check that jackshaft adjustment plate and drum shaft is facing up, and motor guard plate is facing out on the back as shown. (Fig.5) Loosen bolts on jackshaft attachment plate for future adjustment. Ensure that plate moves easily up and down and from side to side. **DO NOT UNBOLT COMPLETELY** (Fig.6)
8. Inspect that frame assembly is straight and well-aligned. Tighten all nuts and bolts to set frame assembly (Fig.7)

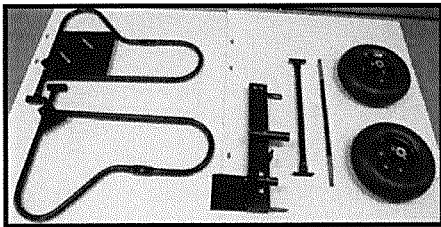

Fig.1: Parts required for frame assembly.

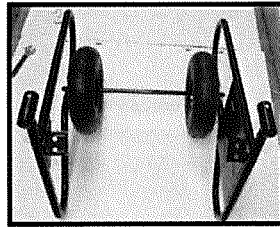

Fig.2: Ensure frames are perpendicular to axle and that wheels are **INSIDE** the frames.



Fig.3: Set axle and frames in position by placing washer, castle nut and cotter pin at the ends of each axle.

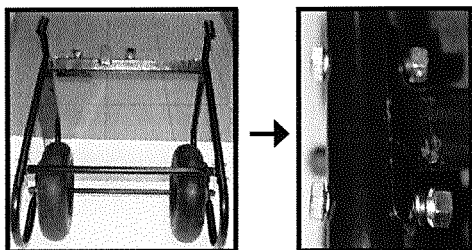

Fig.4: Bolt front support bar as shown. Ensure that the bar fits snugly and is perpendicular to the frame.

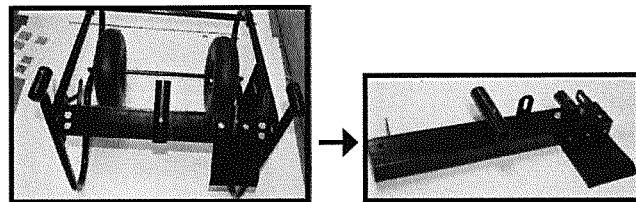

Fig.5: Correct placement and orientation of drum support beam.

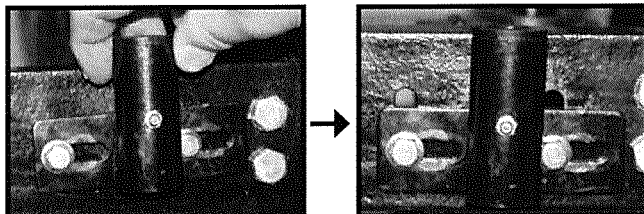

Fig.6: Jackshaft support plate should move freely with positioning slots.

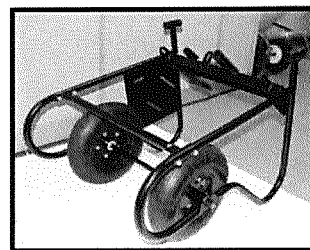

Fig.7: Correctly set-up frame assembly.

Assembling the Mixer Drum:

1. Sort through all the components and set aside pieces required for the drum. Remove lock ring from rod (Fig.8)
2. Place rubber protection pad onto drum attachment plate assembly. Ensure pad fits flush with plate assembly (Fig.9)
3. Slide assembly inside drum and through opening at the bottom. Verify that ALL HOLES LINE UP THROUGH THE DRUM AND ASSEMBLY (Fig. 10)
4. Place bolts through the holes to attach assembly to drum as shown (Fig. 11)
5. Slide mixing drum gear onto shaft. Bolt mixing drum gear, drum, and assembly together with matching nuts. DO NOT OVERTIGHTEN (Fig. 12)
6. Complete drum assembly as shown (Fig. 13)

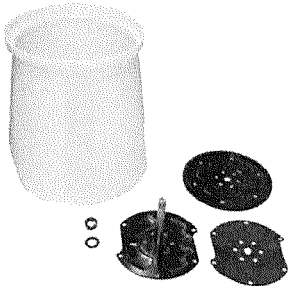

Fig.8: Parts required for drum assembly.

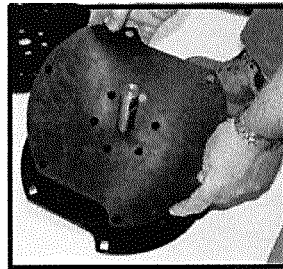

Fig.9: Line up holes on both rubber pad and plate assembly.

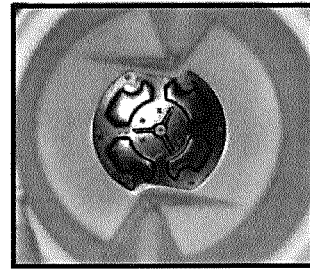

Fig.10: Verify that the holes of the mixing drum, the plate assembly and rubber pad are properly aligned.

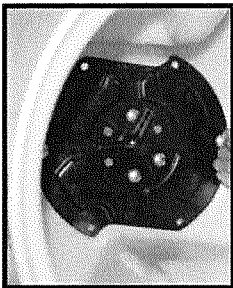

Fig.11: Slide bolts through drum attachment assembly and mixing drum by turning the drum onto its side.

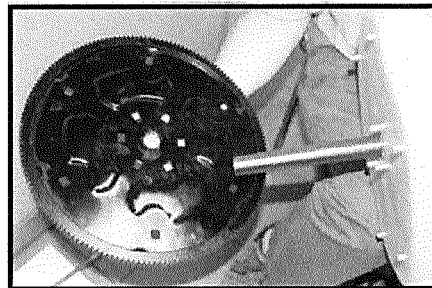

Fig.12: With drum on its side, slip mixing gear onto drum shaft and add nuts to secure assembly.

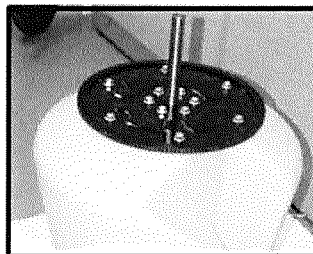
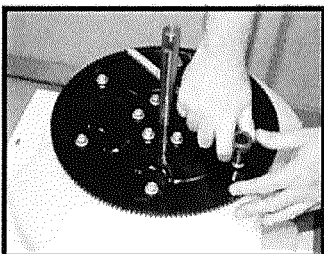
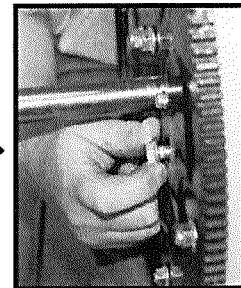

Fig.13: Turn drum assembly over and complete tightening of bolts.

Attaching the Motor, and Drive Assembly to Frame

1. Sort through all the components and set aside pieces required for mounting the motor and drive assembly. (Fig.14)
2. Remove lock ring from jackshaft (Fig.15)
3. Bolt motor onto guides on left side frame. (Fig.16)
4. Slide jackshaft and drive pulley into jackshaft plate on the drum support beam. ENSURE THAT THE LOCK RING IS REMOVED FROM JACKSHAFT. (Fig.17). Fig. 18 shows the incorrect positioning of the lock ring.
5. The motor and drive assembly should be mounted onto cart as shown. (Fig. 19).
6. Slip v-pulley drive belt onto both pulleys, taking care to place belt securely inside each groove. (Fig.20)

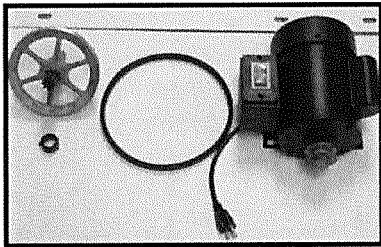

Fig.14: Parts required for mounting motor and drive assembly.

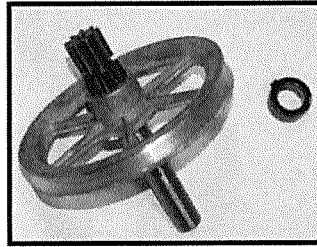

Fig.15: Ensure that lock ring has been removed from jackshaft.

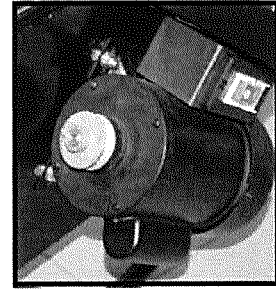

Fig.16: Align motor to mounting slots on left frame and bolt in place.

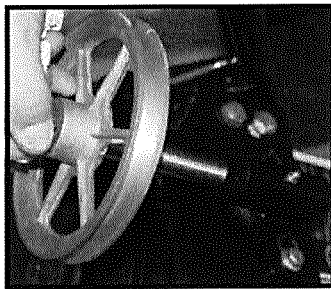

Fig.17: Correct placement of jackshaft (WITHOUT JACKSHAFT)

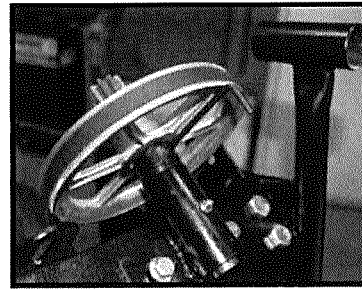

Fig.18: Incorrect positioning of lock ring for jack shaft.

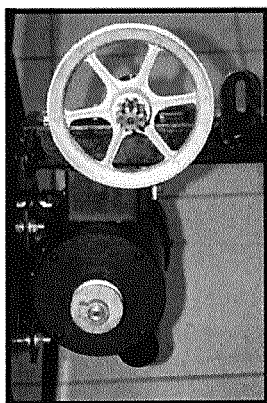

Fig.19: Correctly mounted motor and drive assembly.

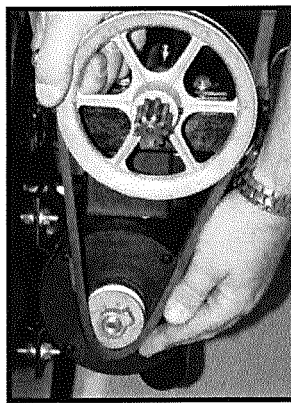

Fig.20: Slip drive belt onto pulleys.

7. Adjusting belt tension and placement:
 - a. Place a ruler across both pulleys. Adjust belt placement by using the jackshaft mounting plate, shifting the plate until both pulleys are flush and aligned to ruler. (Fig.21) Finger tighten bolts on the adjustment plate. (Fig.22)
 - b. Place drum onto drum support beam. There may be a gap between the drive assembly gear and the mixing drum gear. (Fig.23)
 - c. Loosen bolts on adjustment plate to shift jackshaft towards mixer drum. (Fig.24). Set jack shaft such that the drum gear is centered onto drive gear, and that their teeth are set flush and straight to each other. (Fig.25) Tighten bolts on adjustment plate to set placement.
 - d. Place a ruler across both pulleys to verify belt alignment and tension. (Fig.26) If the pulleys are not aligned to ruler, loosen motor mounting bolts on motor and adjust motor along guides (Fig.27) until both pulleys and belt are properly set. (Fig.28).
8. Refer to (Fig.29) to verify frame assembly with the motor and drive assembly attached.

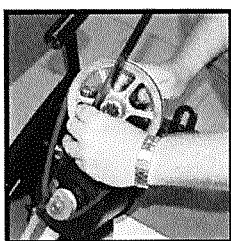

Fig.21: Use a ruler as a guide to belt adjustment.

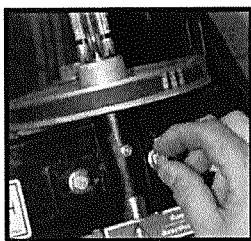

Fig.22: Finger tighten bolts on adjustment plate for a rough setting of belt adjustment.

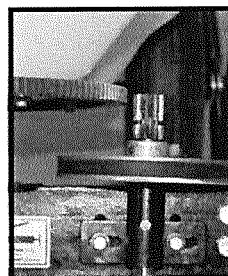

Fig.23: Gap between drive assembly and mixing drum gear.

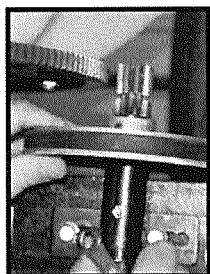

Fig.24: Loosen bolts on jackshaft adjustment plate to shift drive assembly.

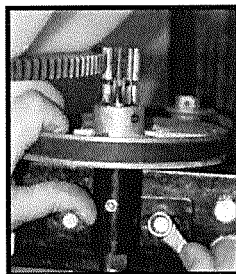

Fig.25: Centre mixing drum gear onto drive gear and tighten jackshaft plate to set adjustment.

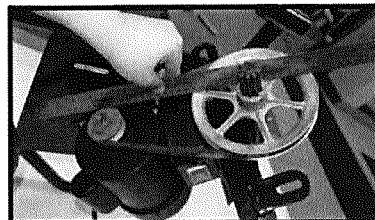

Fig.26: Verify adjustments with ruler.



Fig.27: Loosen motor mounting bolts to move motor for further adjustments as needed.

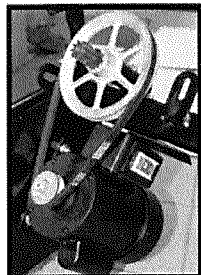

Fig.28: Correctly mounted drive belt, drive assembly and motor

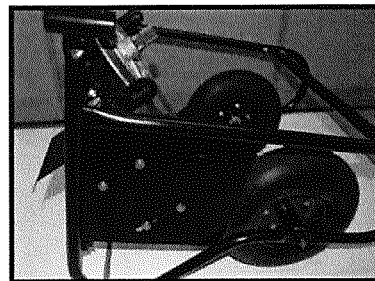

Fig.29: Frame assembly with drive belt, drive assembly and motor

Attaching the Mixer Drum to the Cart Base

1. Slide washer onto shaft of mixer drum (Fig.30).
2. Place assembly onto drum support mount (Fig. 31)
3. Verify that the drum gear and drive gear are aligned as shown (Fig.32). Adjust as per "Adjusting belt tension and placement" section detailed above if needed.
4. Turn mixer drum to ensure smooth movement of gears and drive belt (Fig.33). If there are any unexpected noises or movement, such as excessive rattling or wobbly pulleys, remove mixer drum and check that all components have been properly mounted and securely attached.
5. Check that the mixer resembles (Fig.34) at this stage, where all gears are flush to each other, the drive belt tension is correctly set and the motor is securely bolted the frame.

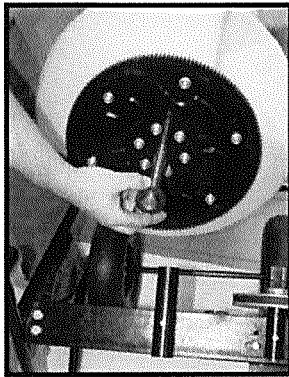

Fig.30: Slide washer onto mixer drum shaft.

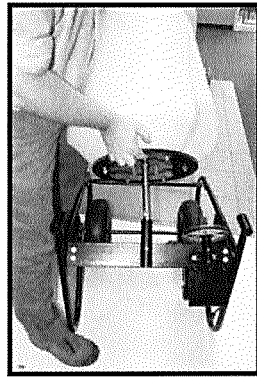

Fig.31: Place mixer drum onto drum support mount.

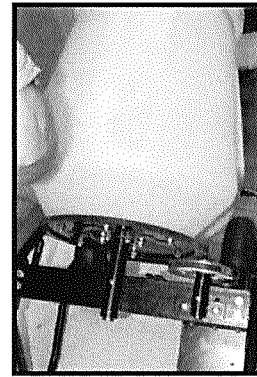

Fig.32: Check alignment of mixer drum gear to drive gear.

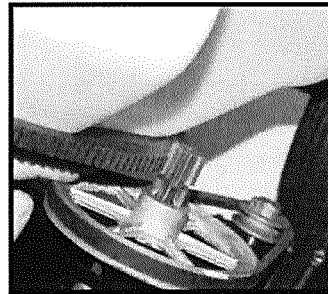

Fig.33: Turn mixing drum to check for smooth operation of mixer. Make sure drive gear and mixing gear are centered and flush to each other.

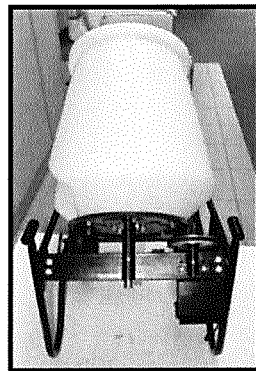

Fig.34: Mixer as completed to this stage.

6. Attaching Gear Guards:

- a. Remove mixer drum from base assembly and place plastic guard for motor and v-pulley over drive mechanism. (Fig.35)
- b. Replace mixer drum (Fig.36)
- c. Ensure that there is sufficient clearance between drum gear and drive gear and the plastic guard such that the drum turns freely without slipping onto plastic guard. (Fig.37)
- d. Remove mixer drum and place plastic guard for drum gear as shown. (Fig.38). The guard should wrap over the guard tabs on the support bar.
- e. Install bolts to secure guards to frame. The drive gear should be centered in the opening of drive gear guard such that it is free from touching the sides and that it can turn freely. Tighten bolts on the guards (Fig.39)
- f. Place lock rings back on the base of the drum shaft and the jackshaft. Using the allen keys provided, secure lock rings to both shafts by tightening the set screws against the flattened part of each shaft. (Fig.40)

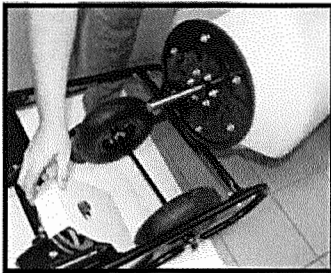

Fig.35: Remove mixer drum and place plastic motor guard over drive mechanism.

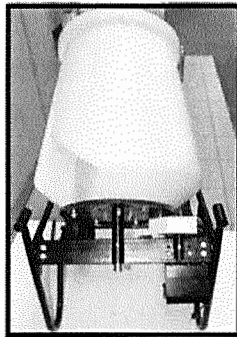

Fig.36: Replace mixing drum.

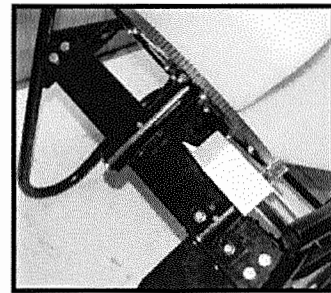

Fig.37: Check for clearance between gears and guard.

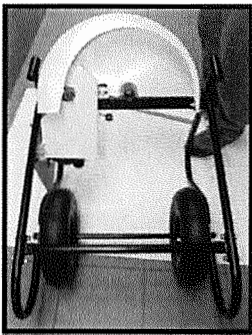

Fig.38: Remove mixer drum and place drum gear guard over mixing drum gear. This guard wraps over the drive assembly guard.

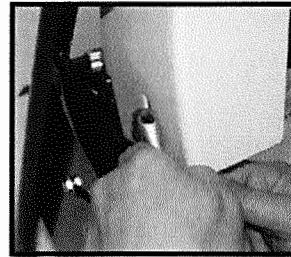
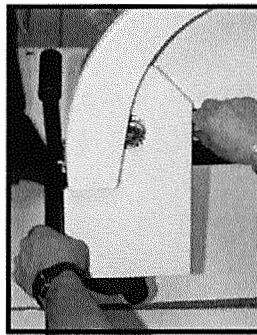

Fig.39: Bolt guards to frame. Note placement of drive gear for clearance from guard. Tighten as shown.

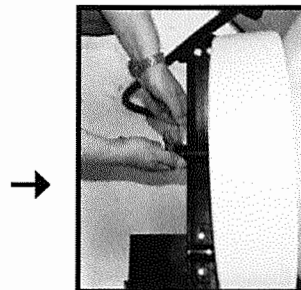
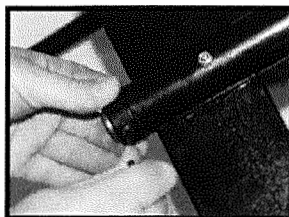

Fig.40: Replace and tighten lock rings on jackshaft and mixing drum shaft.

Completing your Mixer:

1. Slide handle bars through the allotted space at the top of each side frame. Due to the drum design, you may have to turn the drum slightly so that the handle bars may slide through without hitting the drum.
2. Insert one handle attachment clip on each side through the frame and handle bar.
3. Slip one handle grip over each handle bar and slide them on until they are snug on the handle. (Fig.41).
4. Inspect mixer for any further adjustments that may be required. Adjust accordingly, and check for any loose nuts and bolts. Tighten any bolts or nuts to set mixer. Bend the cotter pins to secure wheels to the axle.
5. Grease jackshaft and drum shaft through zerks before operating.
6. The mixer is now in its working position. (Fig.42).
7. To transport the mixer, remove handle attachment clips, slide handles forward, and re-insert the clips at the ends of the handle bar as shown. (Fig.43.) If you have any difficulties moving the handle bars, turn the drum until handles slide through.

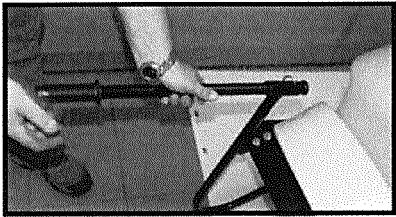

Fig.41: How to install handles.

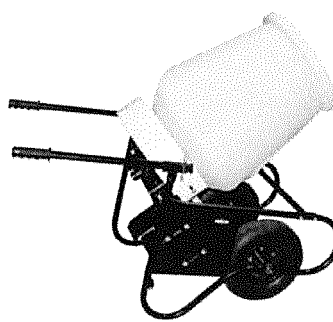

Fig.42: Mixer in working position

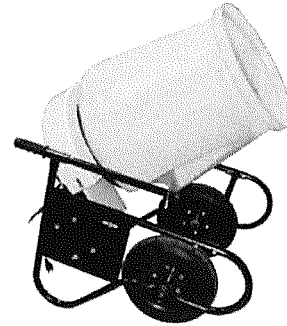
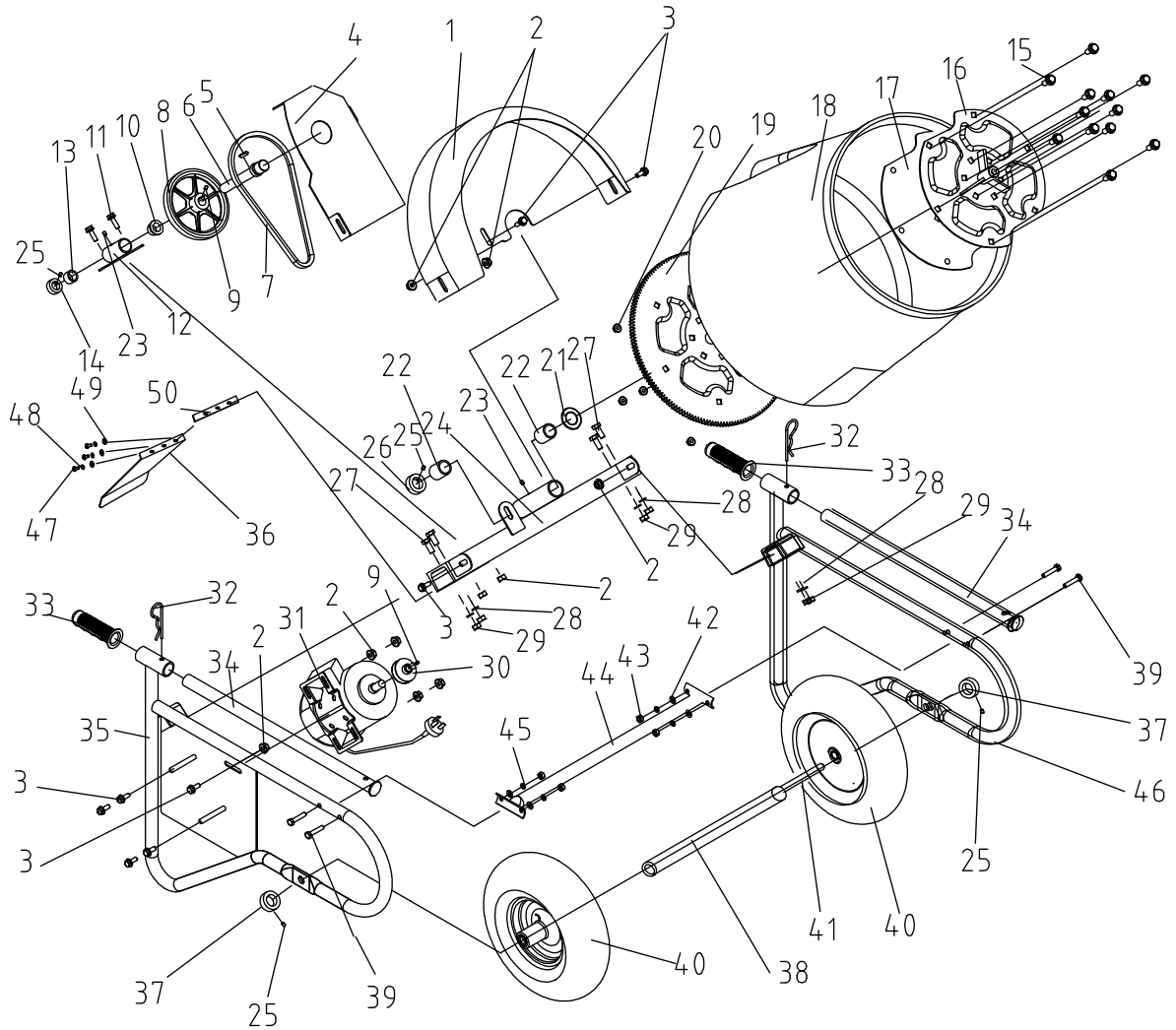

Fig.43: Mixer in travel/
storage position

#12-238 3.5 Cu. Ft. Concrete Wheelbarrow Mixer



PARTS LIST

Ref#	Key#	Detail	Qty/Unit	Ref#	Key#	Detail	Qty/Unit	Ref#	Key#	Detail	Qty/Unit
12-238	1	Gear Guard Cover	1	12-238	18	Roller	1	12-238	35	Right Support Assembly	1
12-238	2	Hex Flange Nut	10	12-238	19	Large Gear Assembly	1	12-238	36	Motor Cover	1
12-238	3	Hex Flange Bolt	8	12-238	20	Hex Flange Nut	12	12-238	37	Shaft Fastening Sleeve	2
12-238	4	Protective Cover	1	12-238	21	Washer	1	12-238	38	Wheel Locating Sleeve	1
12-238	5	Flat Key Style A	1	12-238	22	Sliding Shaft Bearing	2	12-238	39	Hex Bolt	4
12-238	6	Gear Shaft	1	12-238	23	Straight Through Oil Cup	2	12-238	40	Wheel	2
12-238	7	Triangle Belt	1	12-238	24	Channel Plate Assembly	1	12-238	41	Wheel Axle	1
12-238	8	Pulley	1	12-238	25	Hex Socket Set Screw	4	12-238	42	Flat Washer	4
12-238	9	Hex Socket Set Screw	2	12-238	26	Shaft Fastening Sleeve	1	12-238	43	Hex Nut	4
12-238	10	Gear Shaft Sliding Bearing	1	12-238	27	Hex Bolt	4	12-238	44	Supporting Tube Assembly	1
12-238	11	Hex Flange Bolt	2	12-238	28	Standard Spring Washer	4	12-238	45	Standard Spring Washer	4
12-238	12	Gear Locating Sleeve Assembly	1	12-238	29	Hex Nut	4	12-238	46	Left and Right Support Assembly	1
12-238	13	Gear Sliding Bearing	1	12-238	30	Pulley	1	12-238	47	Phillips Pan Screw M5X10	3
12-238	14	Gear Shaft Fastening Sleeve	1	12-238	31	Motor	1	12-238	48	Standard Spring Washer	3
12-238	15	Round Head Square Neck Screw	12	12-238	32	Knob Clip	2	12-238	49	Flat Washer	3
12-238	16	Fixed Plate Stiffening Plate Assembly	1	12-238	33	Knob Glove	2	12-238	50	Seal Washer	1
12-238	17	Roller Pad	1	12-238	34	Knob Flap	2				

Order by Reference # and Key # Toll Free Order Hotline 800-444-7060

Pre-Operation Procedures

Before using the Bon Tool Concrete Wheelbarrow Mixer, please perform the following procedures for the personal and property safety of the operator and jobsite and for optimal performance.

Before operating the concrete mixer ensure that it is structurally and mechanically safe by checking the following:

- a. Perform a detailed visual inspection on the machine with particular attention to the following:
 - i. Are there any loose, worn or damaged parts and decals? If so, **DO NOT ATTEMPT TO OPERATE THE MACHINE**. Make note of required parts, including decals, and contact Toolway Industries for replacement parts and further assistance to service the unit **PRIOR** to any further use.
 - ii. Is the machine, particularly the drive gear and mixing drum gear, clean and free of debris? Small rocks and other foreign objects can jam machine and cause the unit to malfunction, leading to serious injury to the operator and property damage on the jobsite.
 - iii. Are there any cracks or damage on the drum and motor? **DO NOT ATTEMPT TO OPERATE THE MACHINE** until it is refurbished to engine factory standards.
- b. Before operating the concrete mixer, perform the following environmental checks:
 - i. Are there any standing pools of water or other conductive liquids and materials that can interfere with the safe operation of the machine at the jobsite?
 - ii. Is there a reliable source of grounded electricity?
 - iii. If using an extension cord, is it in good condition and conforming to local safety codes? Extension cords must be a 3-pole cord with a 3-pole plug and socket, rated for outdoor use.

Our recommendation is as follows:

1. Up to 100' ft. = 14 AWG
2. Up to 200' ft. = 12 AWG
3. Up to 300' ft. = 10 AWG
4. Up to 400' ft. = 8 AWG



If any of the above checks fail, please take necessary steps to maintain or repair the unit before operating it in any environment.

Operation Procedures

Preparing to Mix

1. Ensure that the concrete mixer is completely turned off prior to adjusting or relocating the unit.
2. Verify that electrical power is supplied from a grounded and safe source, and that the source is of the same voltage to that specified on the machine.
3. If using an extension cord, connect it to the mixer, then plug the other end into the grounded receptacle.
4. Verify that handles are fully extended to working position.

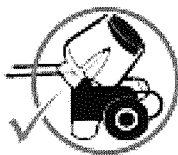

Fig.41: Correct placement of handles for WORKING position.



Fig.42: Incorrect placement of handles for WORKING position.



NEVER OPERATE MIXER WITH HANDLES IN TRAVEL/ STORAGE POSITION.
Handles will block drum from spinning freely, leading to possible machine damage and severe bodily harm.

5. Start machine. Observe for any unusual wobbling, vibrations, or other signs that indicate poor assembly, maintenance, or debris jammed in the gears. Stop machine immediately if any such signs are exhibited.

Operation Procedures continued

Loading the Mixer

The Bon Tool Concrete Wheelbarrow Mixer is designed to mix 2 cu.ft of concrete or mortar. **NEVER** exceed this recommended Our suggested mixing instructions are as follows.

ALWAYS VERIFY WITH YOUR PRE-MIX MANUFACTURER'S INSTRUCTIONS PRIOR TO STARTING. THE INSTRUCTIONS FROM YOUR PRE-MIX MANUFACTURER WILL SUPERCEDE ANY OF OUR RECOMMENDATIONS BELOW.

1. Mixing Mortar

a. You will need:

- i. 2 gallons of water (+ ½ gallon for finish)
- ii. 2 x 80 lb bags pre-mix cement

b. Pour in 2 gallons of water into mixing drum.

c. Slowly add in one bag of pre-mix cement, and allow mixer to slowly fold in mixture.

NOTE: Mixture will be very sloppy.

d. Once the mixture is well mixed, **SLOWLY** add in remaining bag of pre-mix.

Allow machine to thoroughly mix the mixture.

e. Add remaining water to adjust concrete to desired consistency.

Allow each ingredient to be well-folded into the mixture before adding the next for smoother and better combined mixture, as well as less stress on the mixer.

2. Mixing Concrete

a. You will need:

- i. 2 gallons of water (+ ½ gallon for finish)
- ii. Gravel or small round stones
- iii. Portland cement
- iv. Masonry sand

b. Pour in 2 gallons of water into mixing drum.

c. Using a 8.5" x 12" square point shovel, add 6 shovels full of gravel or round stones.

d. Using the same shovel, add in 2 shovels full of Portland cement.

e. Slowly add in 4 shovels full of masonry sand.

NOTE: Your mixture's consistency will vary according to the moisture content in the sand and gravel used.



For optimum mixer performance and results, **DO NOT EXCEED RECOMMENDED VOLUMES.**

C. Unloading the Mixer

When mixture reaches desired consistency, lift mixer using the handles and pour mixture out as required.

NEVER ALLOW MIXTURE TO HARDEN. ADD WATER AS REQUIRED TO MAINTAIN MOISTURE LEVEL.

DO NOT STOP MIXER FROM ROTATING AS MIXTURE MAY SIT AND HARDEN.



DO NOT USE ANY TOOLS, SUCH AS SLEDHAMMERS, TO FORCIBLY KNOCK OUT HARDENED MIXTURE. THE MIXING DRUM CAN BE DAMAGED, AND THE ALIGNMENT BETWEEN THE DRIVE GEAR AND MIXING DRUM GEAR MAY REQUIRE READJUSTMENT PRIOR TO FURTHER USE.

Operation Procedures continued

Cleaning the Mixer

1. After each batch of concrete has been used, spray water into the rotating drum, allowing the water to rinse out any concrete or mortar.
2. Add one shovel full of coarse sand into drum to scour drum and remove any remaining mixture.
3. Empty mixer of the sand, water and any remaining debris. Repeat if necessary.
4. Ensure that the drum is completely clean BEFORE mixing the next batch of concrete or mortar. A clean drum is essential to obtain the best mixing results.
5. Shut down mixer and disconnect from power source.

Storing the Mixer

1. Ensure that the area in which the machine will be stored is well-ventilated and free of any potential fire hazards such as open flames, gas appliances, furnaces, water heaters, and other appliances.
2. Clean and lubricate machine prior to storage.
3. Touch-up any scratches or damaged area exposing metal to the elements.
4. Order and re-apply any safety labels. Refer to "Information on Safety Decals" in "Parts Breakdown Section" of the manual for placement and parts numbers.
5. Store unit in storage position in a covered or indoor storage area for increased protection and longevity.

Maintenance Procedures

The following are general guidelines for servicing common wear components on the Bon #12-238 Concrete Mixer. **ALL MAINTENANCE AND SERVICE WORK MUST BE PERFORMED BY A TRAINED AND EXPERIENCED TECHNICIAN.** Ensure that the work area is clean and free of debris prior to starting any maintenance or service work. Small particles may become trapped in key components that may lead to serious damage to the machine and cause severe bodily harm to the operator or technician.

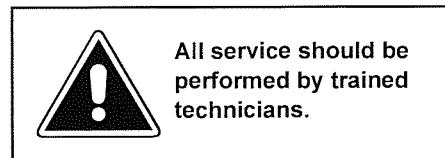

Before performing any service and maintenance procedures, consult these general safety procedures for a safe working environment.

1. Make sure that the motor is cool prior to any service or maintenance work.
2. Verify that work area is clean and free of any debris, tripping or fire hazards, and other potential sources of danger.
3. Always wear proper safety clothing and equipment for the job. These can and should include eye and ear protection, protective helmets, gloves, dust mask and any other items that are appropriate for the job and jobsite requirements
4. Ensure that the technician has tied back or remove any loose hair, clothing and any other potential hazards and obstructions
5. Block the wheels.

Maintenance Procedures continued



Technician should read and thoroughly understand all manuals pertaining to the machine to be serviced. Do NOT proceed with any service and maintenance activity until ALL questions and concerns have been addressed.



ALWAYS consult and verify that all local codes and bylaws are followed before performing any service or maintenance procedures.

The Bon Concrete Mixer is designed to be a low-maintenance unit. Provided that the unit has not been subjected to abuse or misuse, there are very few service items required. By following the Inspection Schedule below BEFORE and AFTER each use of the concrete mixer, appropriate actions can be taken to extend the service life of the machine and reduce any costly repairs and unnecessary downtime for the unit.

Item	Yes	No
Are all nuts and bolts complete and tightened?		1
Is the drum in good condition, with no evidence of cracks or leaks?		1
Is the drum clean and free of any hardened cement or mortar?		1
Are the tires properly inflated?		1
Is the drive belt tension set properly?		2
Does the drive belt show signs of wear and tear?		1
Are the gears in proper alignment?		1
Is the electrical cord in good condition with no fraying, cuts or other signs of damage?		2
Are both the jackshaft and mixing drum assembly well-lubricated?		1
Are there any missing parts?		1
Are the safety warning labels and other decals clearly identifiable and legible? If not, ensure that fresh decals will be re-applied prior to use for operator safety.		1

Instructions on gear alignment and how to change the drive belt can be found in the section "Assembly" under "Attaching the Motor, and Drive Assembly to Frame" and "Attaching the Mixer Drum to the Cart Base".